

16K Serial EEPROM with I2C bus

KK24LC16

DESCRIPTION

The KK24LC16 is a 16K bit Electrically Erasable PROM. The chip is organized as eight blocks of 256 x 8 bit memory with a 2-wire serial interface. Low voltage design permits operation down to 2.5 volts with standby and active currents of only 5 μ A and 1 mA respectively. The IZ24LC16B also has a page-write capability for up to 16 bytes of data.

FEATURES

- Single supply with operation down to 2.5V
- Low power CMOS technology
 - 1 mA active current typical
 - 10 μ A standby current typical at 5.5V
 - 5 μ A standby current typical at 3.0V
- Organized as 8 blocks of 256 bytes (8 x 256 x 8)
- 2-wire serial interface bus, I²C compatible
- Schmitt trigger inputs for noise suppression
- Output slope control to eliminate ground bounce
- 100 kHz (E-temp) and 400 kHz (C/I-temp) compatibility
- Self-timed write cycle (including auto-erase)
- Page-write buffer for up to 16 bytes
- 2 ms typical write cycle time for page-write
- Hardware write protect for entire memory
- Can be operated as a serial ROM
- 1,000,000 erase/write cycles guaranteed
- Data retention > 200 years
- Temperature range -40°C to +85°C

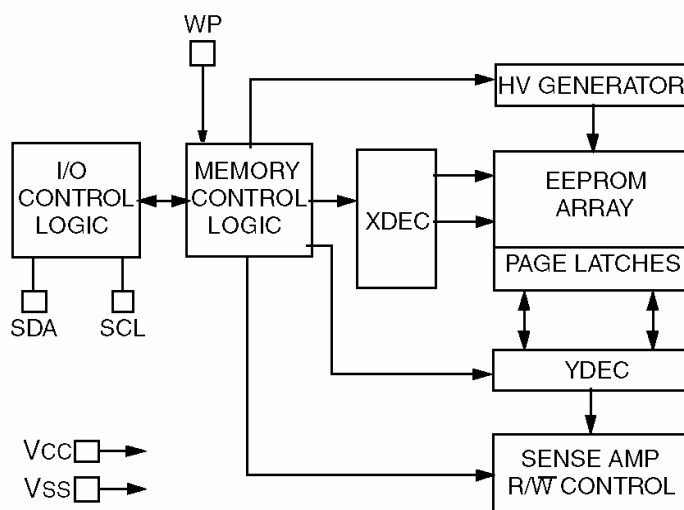
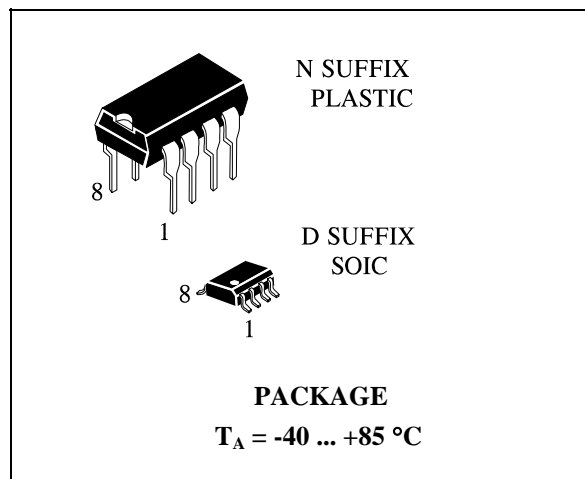

Figure 1. Representative Block Diagram

ELECTRICAL CHARACTERISTICS
Absolute Maximum Ratings

Symbol	Parameter	Value		Unit
		min	max	
V _{CC}	Supply voltage	0	7.0	V
V _I	Input voltage	-0.3	V _{CC} +1V	V
T	Storage temperature	-65	150	°C
T _a	Ambient temperature	-65	125	°C

Maximum Ratings

Symbol	Parameter	Value		Unit
		min	max	
V _{CC}	Supply voltage	2.5	5.5	V
I _{OL}	Low level output current	-	3.0	mA
T	Operating ambient temperature	-40	85	°C

DC CHARACTERISTICS (V_{CC} = +2.5V to +5.5V T_{amb} = -40°C to +85°C)

Symbol	Parameter	Mode of measurements	Value		Unit
			Min	Max	
I _{CCS}	Standby current	V _{CC} = 3.0 V V _{CC} = 5.5 V SDA=SCL= V _{CC}	-	30 100	uA
I _{CCO(RD)}	Operating current (read mode)	f _{SCL} = 400 kHz V _{CC} = 5.5 V		1.0	mA
I _{CCO(E/WR)}	Operating current (erase/write mode)	f _{SCL} = 400 kHz V _{CC} = 5.5 V		3.0	
I _{LI}	Input leakage current	V _{IN} = (0.1 - 5.5) V	-10	10	uA
I _{LO}	Output leakage current	V _{OUT} = (0.1 - 5.5) V	-10	10	
C _{IN}	Input pin capacitance	V _{CC} = 5.0 V, f = 1 MHz T = 25 °C	-	10	pF
C _{out}	Output pin capacitance	V _{CC} = 5.0V, f = 1 MHz T = 25 °C		10	
V _{HYS}	Hysteresis of Schmitt trigger inputs		0.05 V _{CC}	-	V
V _{OL}	Low level output voltage	I _{OL} = 3.0 mA, V _{CC} = 2.5 V	-	0.4	
t _S	Time of data storage	T = 25 °C	200	-	years
N _{C(E/WR)}	Number of ERASE/WRITE cycles guaranteed		100000 0		pcs

N SUFFIX PLASTIC DIP (MS - 001BA)

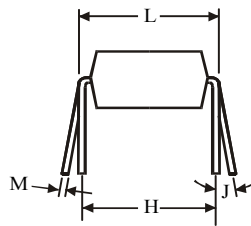
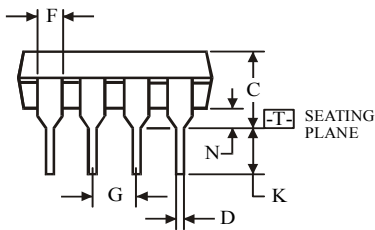
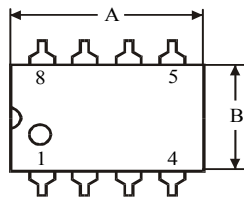
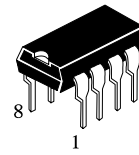

$\oplus 0.25 (0.010) \text{ (M) T}$

Symbol	Dimension, mm	
	MIN	MAX
A	8.51	10.16
B	6.1	7.11
C		5.33
D	0.36	0.56
F	1.14	1.78
G	2.54	
H	7.62	
J	0°	10°
K	2.92	3.81
L	7.62	8.26
M	0.2	0.36
N	0.38	

NOTES:

- Dimensions "A", "B" do not include mold flash or protrusions.
Maximum mold flash or protrusions 0.25 mm (0.010) per side.

D SUFFIX SOIC (MS - 012AA)

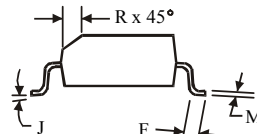
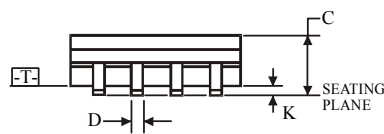
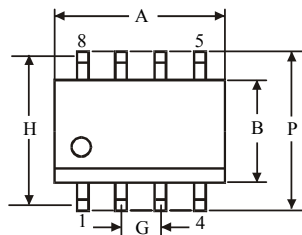
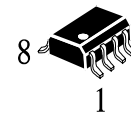

$\oplus 0.25 (0.010) \text{ (M) T C (M)}$

Symbol	Dimension, mm	
	MIN	MAX
A	4.8	5
B	3.8	4
C	1.35	1.75
D	0.33	0.51
F	0.4	1.27
G	1.27	
H	5.72	
J	0°	8°
K	0.1	0.25
M	0.19	0.25
P	5.8	6.2
R	0.25	0.5

NOTES:

- Dimensions A and B do not include mold flash or protrusion.
- Maximum mold flash or protrusion 0.15 mm (0.006) per side for A; for B - 0.25 mm (0.010) per side.